

FieldSmart FDP Indoor/Outdoor Wall Boxes

Installation Manual



FieldSmart FDP Indoor/Outdoor Wall Boxes

Installation Manual



Table of Contents

Application	3
Description	3
Technical Specifications	3
Mounting the Wall Box	4
Installing Sealcons	5
Mid-Spanning Cable	6
Installing Cassettes	8
Installing xPAKs	9
Installing Deploy Reels	10
Connector Cleaning Procedure	11
Standard Warranty	16
Proprietary Notice	17
Technical Support	17



FieldSmart FDP Indoor/Outdoor Wall Boxes

Installation Manual

Application

Ideal for any small count fiber scenario, the FieldSmart Fiber Delivery Point (FDP) Wall Box accepts up to two Clearview® Blue Cassettes, providing up to 24 fibers in a discrete footprint, or a single Clearview xPAK of 6 fibers in the small wall box, without sacrificing fiber management. The lockable enclosure is compact, making it ideal for a variety of applications, including harsh environment locations surrounding fiber demarcation, entrance facilities, FTTP drop boxes and cell backhaul. Additional applications include MDU, business class services, power and wind farms and DOT/Traffic monitoring.

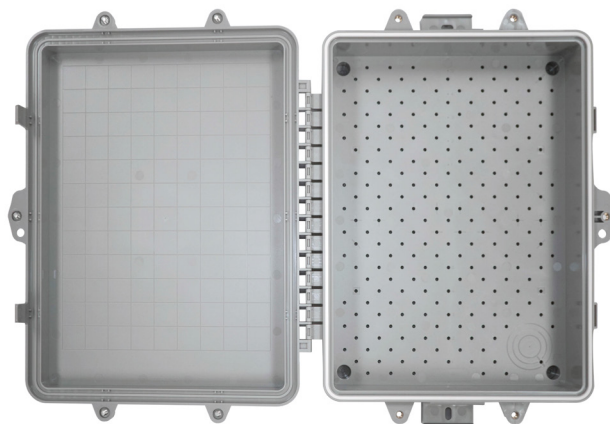

Description

As a lower cost alternative to sheet-metal designs, this lockable plastic enclosure is consistent with Clearfield's long-standing reputation of delivering simple solutions for complex problems. Optimized for use with the Clearview xPAK, Blue Cassette, or Deploy Reel, the FieldSmart Fiber Delivery Point Wall Box is ideal for any small count fiber scenarios where a discrete footprint without sacrificing fiber management is required. Standardizing on a craft-friendly, building block architecture reduces the operating costs of fiber deployment by reducing installation times and inventory carrying requirements.

Technical Specifications

FieldSmart FDP Wall Boxes	FDP Large/Mid-Span	FDP Small	FDP Mini
Dimensions	17.55" H x 12.78" W x 4.17" D	13.08" H x 8.44" W x 3.82" D	12.17" H x 8.62" W x 3.91" D
Port Count	Up to 24 Ports	Up to 6 Ports	1 Port
Cassette Types Supported	Clearview Blue	Clearview xPAK	FieldShield Deploy Reel
Splice Capacity	24 splices in each Clearview Blue Cassette	Six Splices in each Clearview xPAK	One connection per Deploy Reel
Connector Types	SC/UPC, SC/APC, LC/UPC, LC/APC		SC/UPC, SC/APC
Cable Types	Indoor Riser, Indoor Plenum, Indoor/Outdoor, Outdoor (Riser/Non-Rated), Outdoor Armored (Riser/Non-Rated), FieldShield®		
Storage Capacity	One meter of 900 µm fiber and up to 5 meters of jacketed fiber		200 ft Fieldshield FLEXdrop
Material	UV Stabilized, Flame Retardant Polycarbonate		
Rating	GR-771 and NEMA-4		GR-771 and Designed for NEMA-4
Items Included	Box, Designation label, 3/4" Strain relief fitting (fits .51-.71" cable;),	Box, 1/2" Strain relief fitting, nut, grommet for .24-.63"	

FieldSmart FDP Indoor/Outdoor Wall Boxes

Installation Manual



Mounting the Wall Box

Unpack the wall box from shipping container and make sure to check for small items that may be included. These would be bagged separately and included in the shipping container.

The wall box is installed via the 2 slots located in the top and bottom of the enclosure. Hold the panel up to the mounting surface and mark the hole locations with a marker.

Note: A level may be used to ensure that the panel is mounted straight.

Pilot holes can then be drilled at each mark. Using appropriate fasteners for the material, attach the panel to the surface.

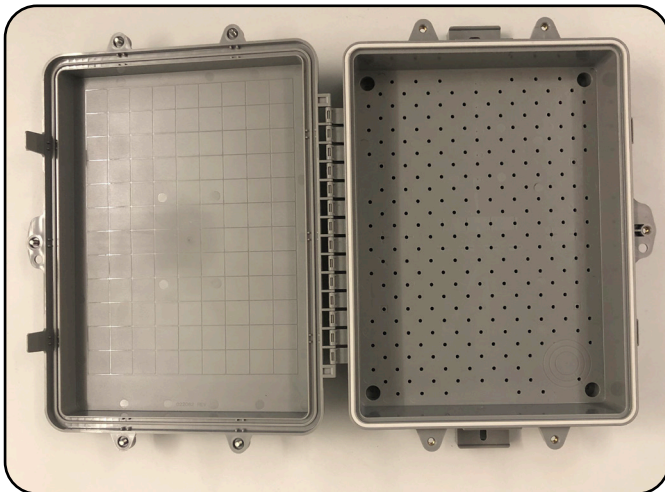

FDP Large Wall Box
Clearview Blue Cassette

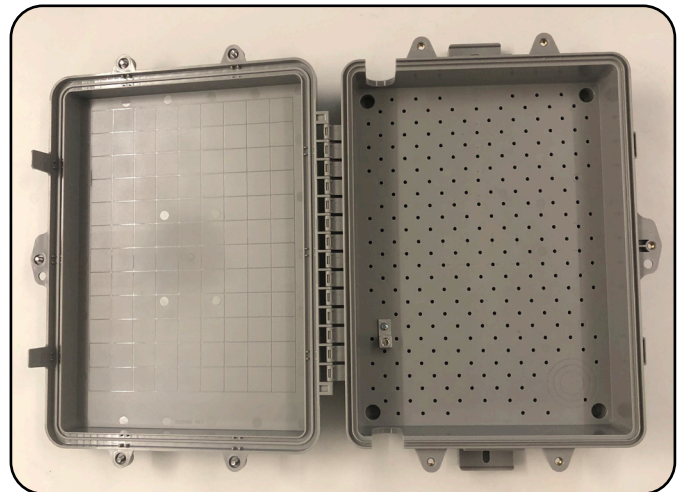

FDP Large Mid-Span Wall Box
Clearview Blue Cassette



FDP Small Wall Box
Clearview xPAK



FDP Mini Wall Box
FieldSmart Deploy Reel

Installing Sealcons

1. Identify the location of the sealcon. On all size boxes, the sealcon locations have been pre-marked on the inside of the box for easy identification. There are at least two sealcon locations for each box.

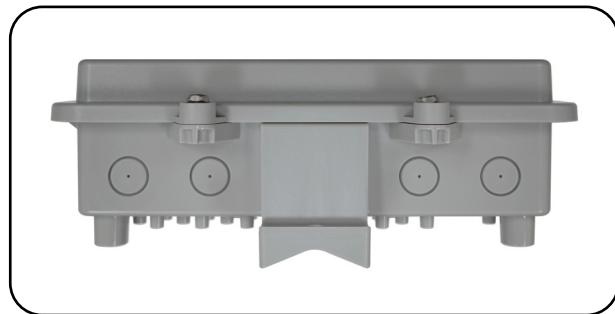

2. Use a drill bit (step drill is preferred tool); drill out the plastic area enough so that the water tight strain relief fitting will fit through the hole.

FDP Large: 1" drill bit for 3/4" sealcon

FDP Small/Mini: 7/8" drill bit for 1/2" sealcon



3. Install the sealcon through the hole, with the threads on the inside of this box. Ensure the O-ring is in place at the top of the sealcon's threads prior to installation.

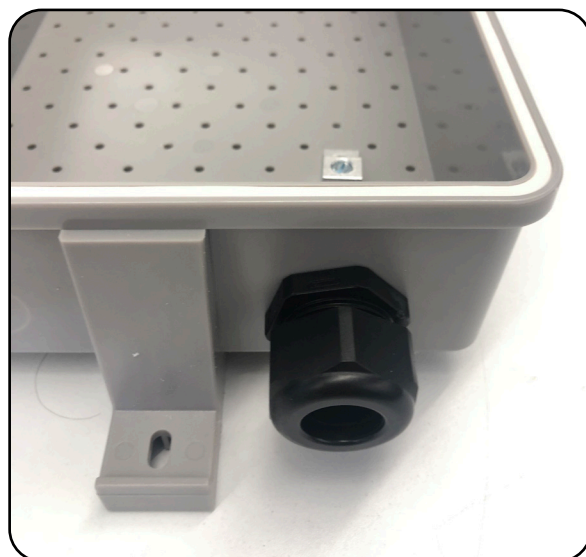
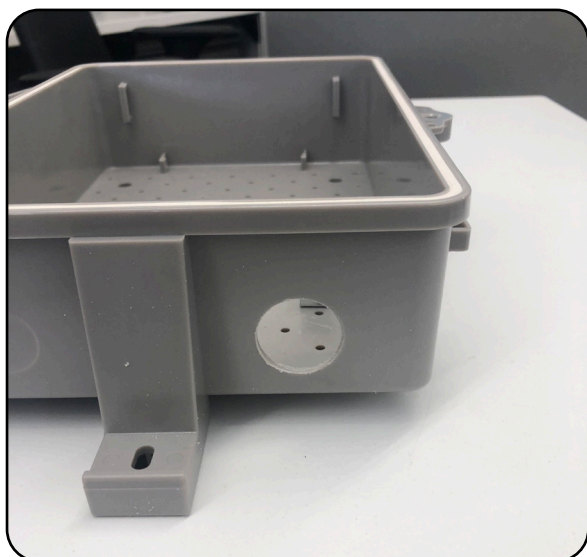

FieldSmart FDP Indoor/Outdoor Wall Boxes

Installation Manual



4. If optional strength clamps are used, install them onto the strain relief threads before installing the nut to tighten.
5. Install the nut onto the threads and tighten securely until the fitting will not rotate.
6. Insert cable through sealcon and tighten dome nut to compress rubber sealing grommet.

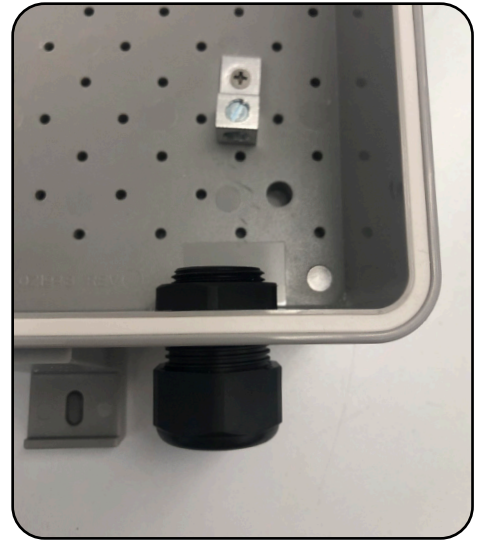
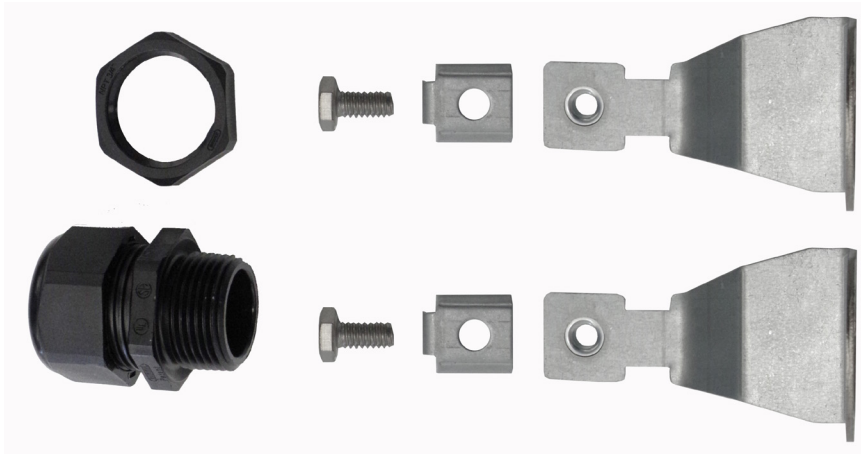

Mid-Spanning Cable

1. Open your cable (Clearfield recommends opening 12ft of cable when mid-spanning inside the Large FDP Wall Box).
2. Secure the cable tie-downs in place near the two mid-span entrances located at the top and bottom of the wall box.

Note: Cable tie-downs have an adhesive backing as well as holes for screws.

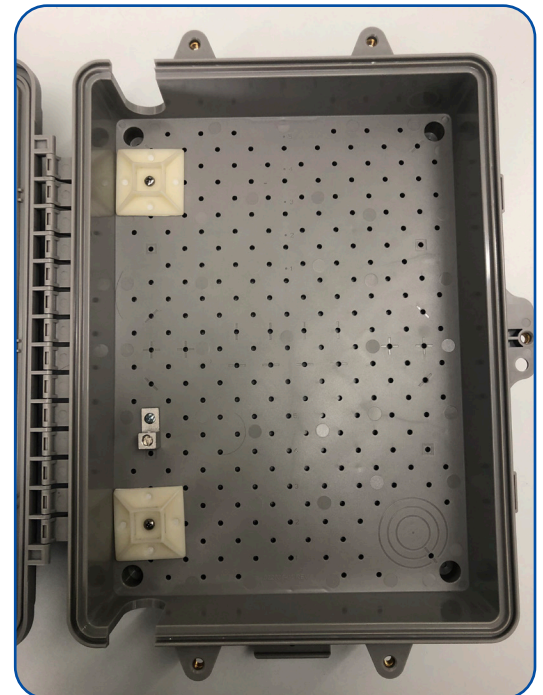

3. Wrap a single layer of grommet tape around both ends of the cable jacket and trim to length.

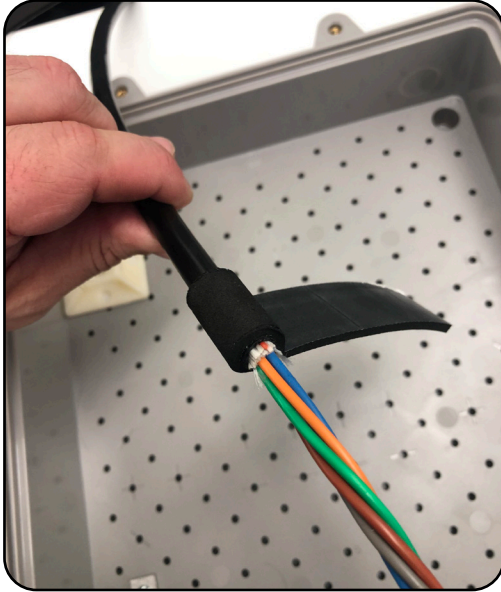

4. Pass a zip tie through each tie down.
5. Secure the ends of the cable jacket with the zip ties at the tie-downs
6. Wrap the buffer tube slack to be stored in the box around the perimeter of the box. Retaining clips from the Cassette U-Mount and velcro can be utilized to manage the slack.

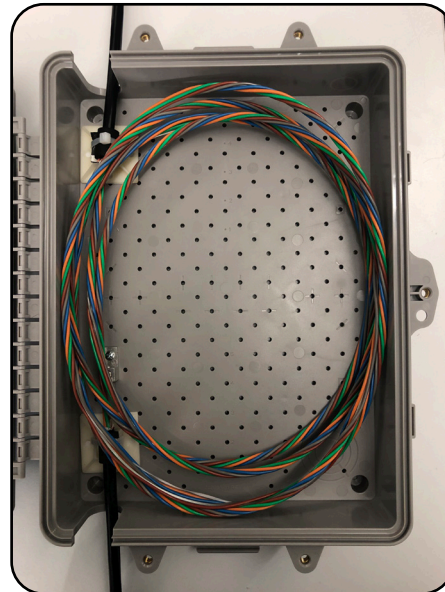
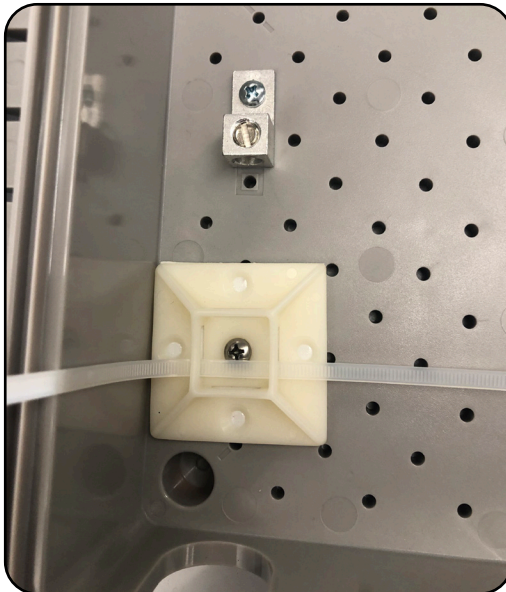

FieldSmart FDP Indoor/Outdoor Wall Boxes

Installation Manual



Installing Cassettes

1. Locate the U-Mount package typically shipped separately inside of wall box.
2. Remove contents from plastic bag and carefully cut the different components from the main bracket. There is an instruction card included with each U-Mount bracket.
3. Assemble U-Mount Bracket per instruction card and place inside of wall box.
4. Once assembled, screw the U-Mount bracket and retaining clips into the wall box. Location for this is on the back of the instruction card.
5. You are now ready to install cassettes into wall box, using the thumb screws to fasten the cassettes to the clear brackets. See Cassette installation manual for additional details.
6. Typical cable/jumper routing is included on the back of the instruction card.

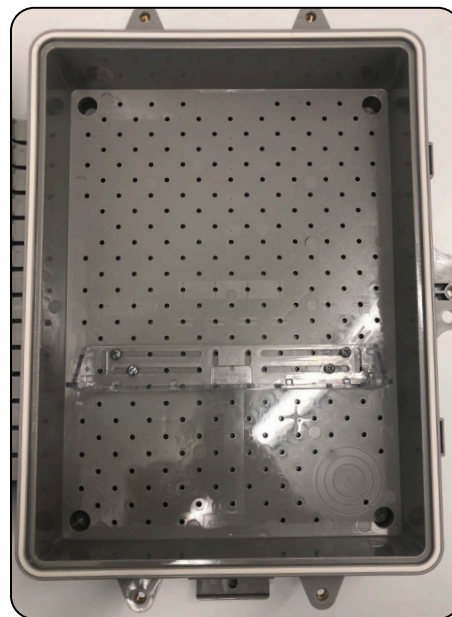
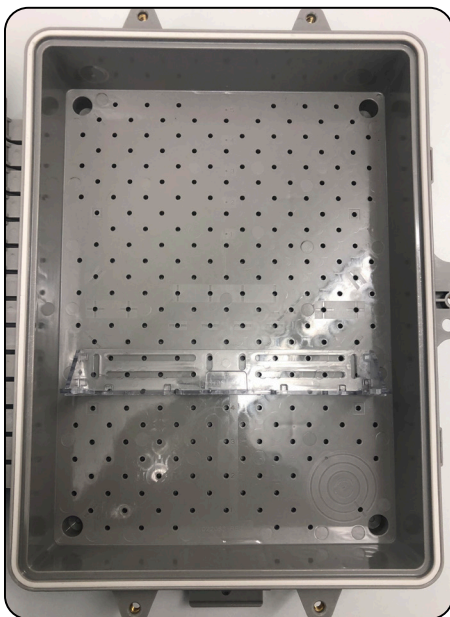
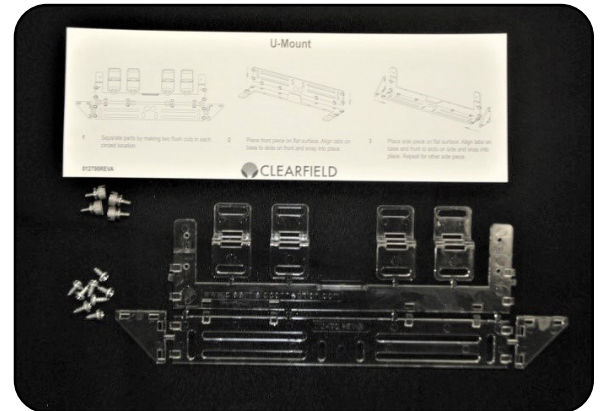

See the Clearview Blue Cassette Installation Manual for splicing instructions, located under the Resources tab of the Clearfield website, www.seeclearfield.com.

Viewable here:

<https://www.seeclearfield.com/assets/documents/installation-manuals/clearview-blue-cassette-install-manual.pdf>



FieldSmart FDP Indoor/Outdoor Wall Boxes

Installation Manual

Installing xPAKs

1. Locate the U-Mount package typically supplied with the xPAK.
2. Remove contents from plastic bag and carefully cut the different components from the main bracket. There is an instruction card included with each U-Mount bracket.
3. Once removed, screw the U-Mount bracket and retaining clips into the wall box. The location for this is located on the back of the instruction card.
4. You are now ready to install the xPAK into the wall box. See Clearview xPAK install manual for details. Typical cable/jumper routing is included on the back of the instruction card.

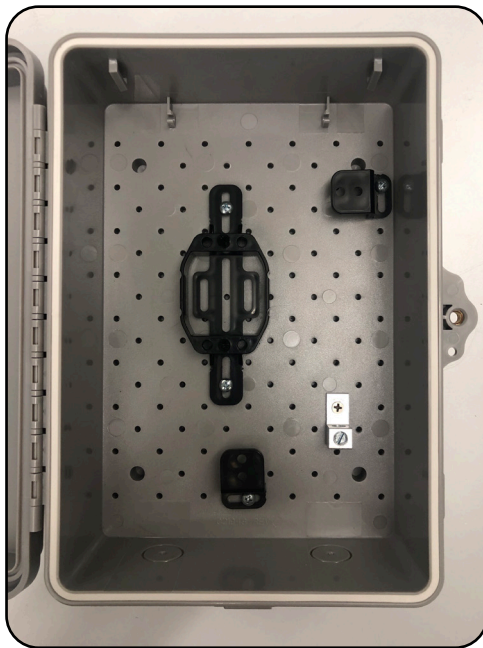
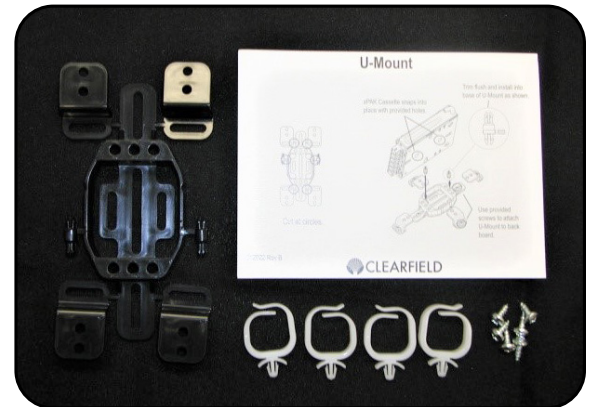

See the Clearview xPAK Installation Manual for splicing instructions, located under the Resources tab of the Clearfield website, www.seeclearfield.com.

Viewable here:

<https://www.seeclearfield.com/assets/documents/installation-manuals/clearview-xpak-install-manual.pdf>

FieldSmart FDP Indoor/Outdoor Wall Boxes

Installation Manual



Installing Deploy Reels

1. Locate the mounting pin typically shipped with the fiber deploy reel.
2. Use the provided screws from the Deploy Reel pack to install the mounting pin. Tighten the first screw until it is halfway in. Install the pin, and the second screw. Tighten both screws fully to secure the pin in place.
3. Mount the Deploy Reel onto the pin. The first position will let the Deploy Reel spin, allowing the fiber to be deployed. Fully depressing the reel will lock it into place, preventing it from spinning and releasing more fiber.



Connector Cleaning Procedure

Whether factory terminated or field spliced, clean connectors are essential for proper system operation. Even the smallest dust particle can cause transmission problems, so for optimal network performance inspect, and if necessary, clean connectors and adapters prior to mating.

Inspect Then Connect

These are Clearfield recommended products/applications. Use the product you feel will complete your cleaning procedures. Create a “best practice” for your company and follow those procedures.

The use of Chemtronics end face and bulkhead cleaning products and techniques ensures a clean end face, no matter the type of contamination.

Before cleaning any connector, be sure you know what type of contaminate you are cleaning (dry, fluidic, or combination). All the available products are good, it's the process that you need to be aware of. Using a dry cleaning method to clean “dirt” can lead to scratching of the end face. Learn the process of cleaning properly.

Note: It is **NOT** recommended to use isopropyl alcohol to clean the end face.

Cleaning an SC/LC Connector

Cleaning the End Face

- Place one wiping paper on QbE-2 FiberSafe™ Cleaning Platen. (Figure 1)
- Apply small amount of precision cleaner (about 1” in diameter) with Electro-Wash MX pen on to one end of the wipe. (Figure 2)
- Hold end face at a 90 degree angle. For APC connection, adjust by slightly tilting the container or end face. Angle is correct when no drag is felt on the end face. (Figure 3)
- Draw end face from wet to dry part of the wipe 3 times. Use just enough pressure to ensure complete contact between end face and the wipe.

Note: **DO NOT** retrace previous step.



Figure 1



Figure 2



Figure 3

Cleaning the Ferrule

- Lightly moisten the fiber optic swab (2.5mm/38542F or 1.25mm/38040) by spotting a small amount (about 1") of Electro-Wash PX or Electro-Wash MX pen onto the QbE. Hold the swab, 1 side down to the wetted area and hold for a count of 1-2-3-4-5. (Figure 4)

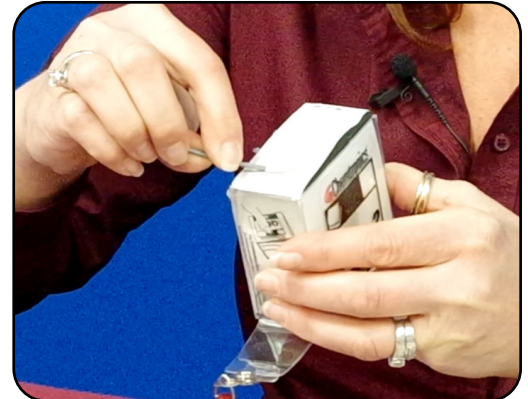

Figure 4

- Insert swab into side of ferrule, wet side to the ceramic ferrule and circle around 2-3 times and remove. Turn swab to dry side and repeat. (Figure 5)



Figure 5

Cleaning the Mate Through an Adapter AND the Adapter Itself

- Lightly moisten the fiber optic swab (2.5mm/38542F or 1.25mm/38040) by spotting a small amount (about 1") of Electro-Wash PX or Electro-Wash MX pen onto the QbE. Hold the tip of the swab onto the wetted area and hold for a count of 1-2-3-4-5.
- Insert the swab into the adapter to the connector, press lightly against the connector, twist 2-3 times, remove and discard.
- Dry with a second dry swab.
- Inspect, repeat cleaning if necessary, and test for signal strength.
- Use additional swabs to clean inside the actual adapter. Moisten swab, like above, and insert through hole and remove while twisting. (Figure 6)

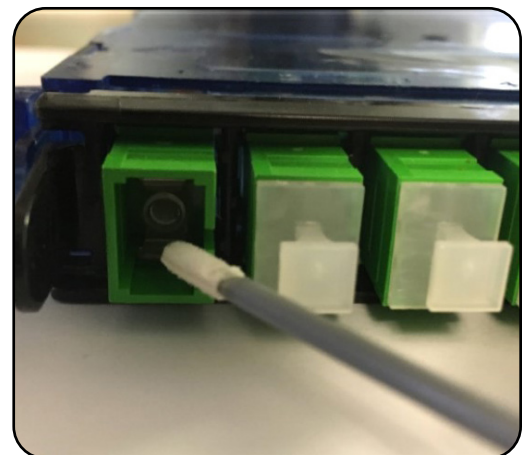
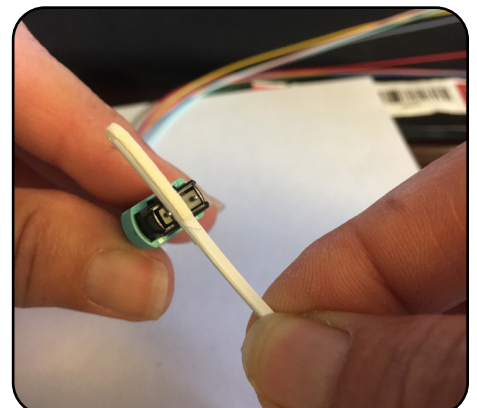

Figure 6

Cleaning an MPO/MTP Connector

Male Connector

- Use of Chemtronics MTP Connector Cleaning Swabs (CC505F) is recommended. Even after cleaning with a probe cleaner, you should always clean the pins with this (or an equivalent) type swab. Cleans ALL MTP/MPO connector end faces. This swab also cleans the “pins” of the male connector
- Lightly “spot” a QbE-2 wipe on the platen with Electro-Wash PX Fiber Optic Cleaner, the FiberWash or MX Pen.
- Lightly touch short side of the MTP/MPO Connector Swab to the wetted area (3-5 secs) to absorb some cleaning solution (DO NOT over saturate the swab).
- Wipe connector areas to be cleaned, sliding pad from bottom of pad across and forward to tip of swab, from 1 side to the other, turn over and use long side to dry in same movement.



FieldSmart FDP Indoor/Outdoor Wall Boxes

Installation Manual



- Use the hole on end of pad to clean one alignment pin, then press the end of the swab into the other pin to clean.
- Check your work with a fiber scope. This can take several attempts to get the endface clean.

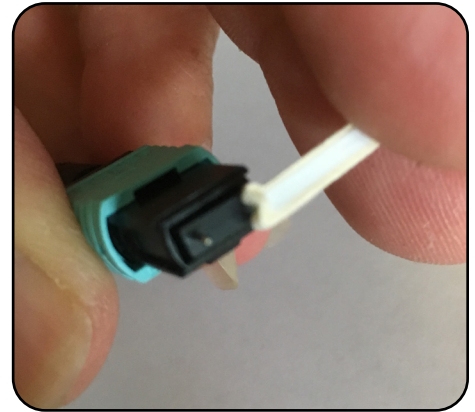
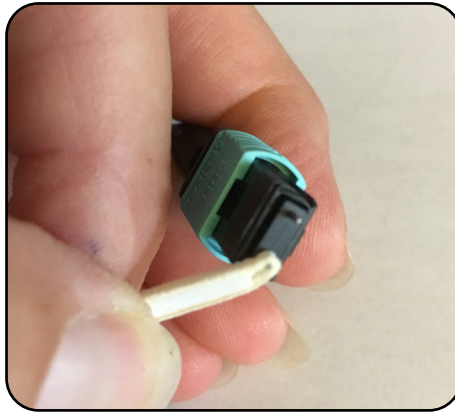

Female Connector (without pins)

- Cleaned like a single fiber connector, using a cleaning platform. The receptacles will be cleaned as long as you are using a combination cleaning process as recommended.
- Again, using a platen, moisten the platen with cleaning solvent on one end to accommodate 3 swipes of the MPO female endface.

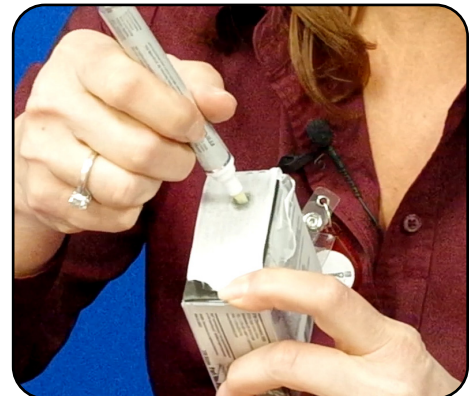

- Holding the connector (If APC, slightly at an angle to accommodate for 8° angle) swiping with medium pressure, from the wet area into the dry area 3 times, without wiping over previous area.
- Inspect, and if clean, make the connection. If NOT, repeat above steps until clean or if determined that the end face is damaged (based on standards of 5 cleanings per connection), replace.

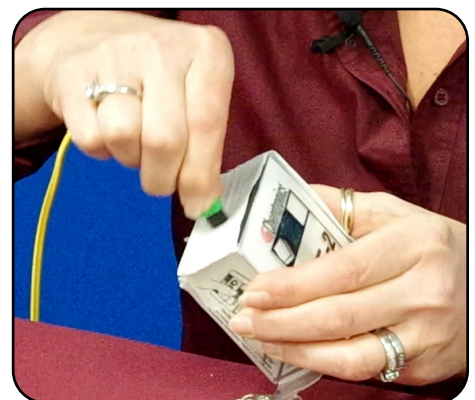

Cleaning Using a Probe-Style Cleaning Tool

- The probe style cleaning tools are capable of cleaning a connector end face separately or through the adapter.
- Slightly engage probe by pulling back but do not allow to click. Lightly “spot” a QbE-2 wipe on the platen with Electro-Wash PX Fiber Optic Cleaner, this will help alleviate “over saturation” of the material.
- Lightly touch the tip of probe and release.

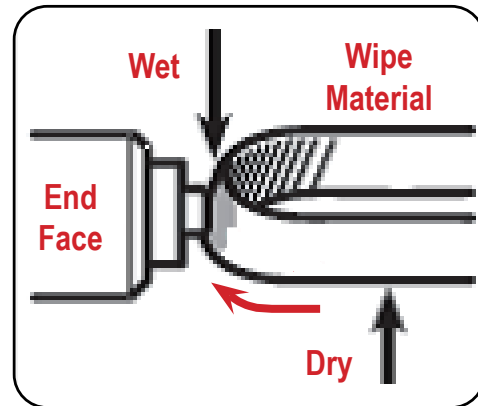

- Insert connector or insert probe through adapter and click 2-3 times to move past the wet area and allow material to dry wipe.

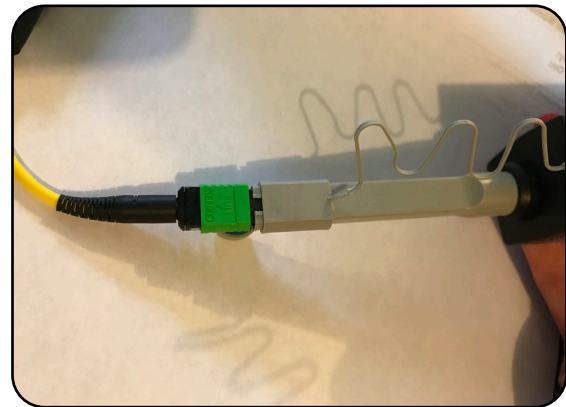
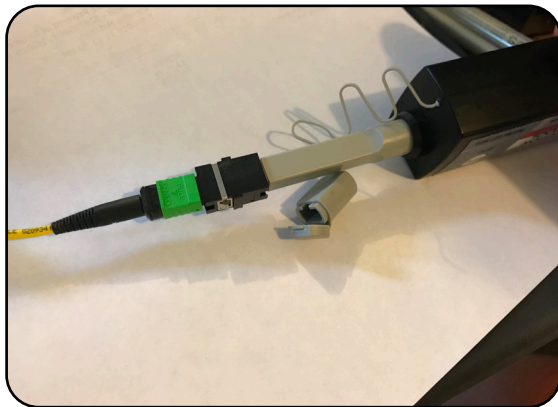

- Inspect connector, repeat if necessary (following standards)
- If cleaning a male connector, clean the pins (see above)

FieldSmart FDP Indoor/Outdoor Wall Boxes

Installation Manual



Standard Warranty

Clearfield warrants to the original purchaser of the Product sold hereunder is free from defects in material and workmanship under normal use and service, subject to exceptions stated herein. Product purchased is warranted as follows: Clearfield designed and branded Products are warranted for three (3) years; Products manufactured by Clearfield to customer prints and/or specifications are warranted for one (1) year; and any Product Clearfield acquires from or through a third-party manufacturer or distributor and resells to Customer as the original customer will carry the manufacturer's pass-through warranty, if any. In all cases, the warranty period commences on the date of shipment to the original purchaser.

Warranty Claim Procedure

If any Product purchased from Clearfield is found defective under the above warranty, the following basic procedure must be followed:

1. Customer must contact Clearfield and obtain a Return Materials Authorization
2. Following authorization, the Customer ships the product-freight collect to Clearfield's manufacturing facility
3. Clearfield shall repair or replace the defective Product at its sole option and discretion, and return the repaired or replacement Product to Customer's site, freight prepaid

Note: If the Product is not found to be defective by Clearfield, the product will be returned to the Customer and the customer billed for freight in both directions.

View our warranty policy here: <https://www.seeclearfield.com/warranty.html>

Limitations of Warranty

Correction of defects by repair or replacement, at the option of Clearfield Inc, shall constitute the exclusive sole remedy for a breach of this limited warranty. Clearfield shall not be liable under any circumstances for any special, consequential, incidental, punitive, or exemplary damages arising out of or in any way connected with the product or with agreement to sell product to buyer, including, but not limited to damages for lost profits, loss of use, or for any damages or sums paid by buyer to third parties. The foregoing limitation of liability shall apply whether the claim is based upon principles of contract, warranty, negligence or other tort, breach of statutory duty, principles of indemnity or contribution, the failure of any limited or exclusive remedy to achieve its essential purpose, or otherwise.

Clearfield will not be responsible for any labor or materials costs associated with installation or incorporation of Clearfield products at customer sites, including any costs of alteration, replacement or defective product, or any field repairs.

Other Limitations

Clearfield assumes no warranty liability regarding defects caused by:

1. Customer's modification of Product, excepting installation activities described in Clearfield documentation
2. Customer re-packaging of Product for shipment to third parties or destinations other than those originally shipped to by Clearfield, or any defects suffered during shipping where the Product has been re-packaged
3. Customer's installation or maintenance, excepting activities described in and performed in accordance with Clearfield documentation
4. Customer's improper or negligent use or application of Product
5. Other causes external to the Product, including but not limited to accidents, catastrophe, acts of God, government action, war, riot, strikes, civil commotion, sovereign conduct, or the acts or conduct of any person or persons not party to or associated with Clearfield
6. Environmental factors and weathering resulting in aging and damage not necessary or applicable to the function of the product



FieldSmart FDP Indoor/Outdoor Wall Boxes

Installation Manual

Proprietary Notice

Information contained in this document is copyrighted by Clearfield, Inc. and may not be duplicated in full or part by any person without prior written approval of Clearfield, Inc.

Its purpose is to provide the user with adequately detailed documentation to efficiently install the equipment supplied. Every effort has been made to keep the information contained in this document current and accurate as of the date of publication or revision.

However, no guarantee is given or implied that the document is error free or that it is accurate with regard to any specification.

Technical Support

Clearfield, Inc. can be contacted for any issues that arise with the supplied product.

If you need to return the supplied product, you must contact the Clearfield, Inc. Customer Service Department to request a Returned Materials Authorization (RMA) number.

Clearfield, Inc.
7050 Winnetka Ave N
Minneapolis, MN 55428

Toll Free: 800.422.2537
Phone: 763.476.6866
Fax: 763.475.8457

Customer Support: sales@seeclearfield.com
Technical Support: techsupport@seeclearfield.com